

# ORIGAMI 72

Design · Tulczinsky

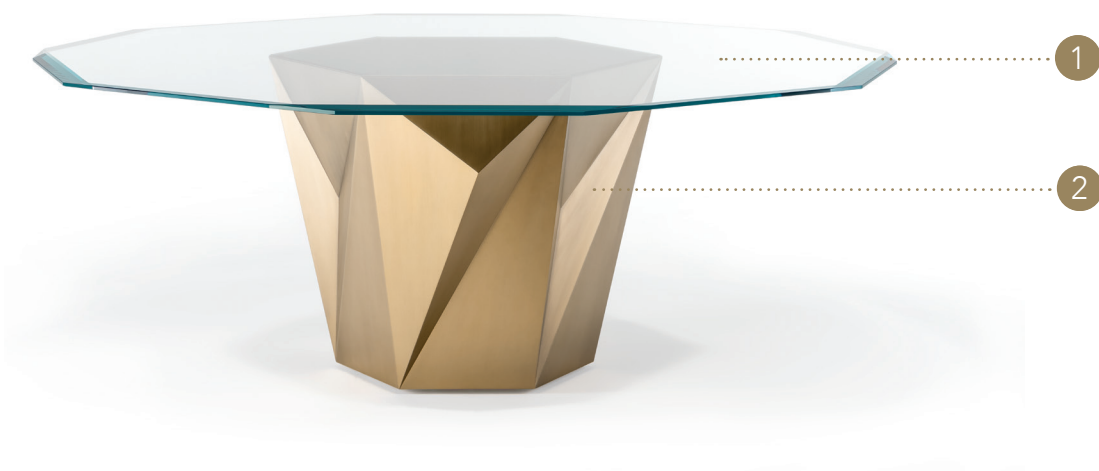

## TOP | 1

Vetro  
Glass

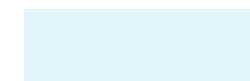

Extrachiaro  
Extra clear



Trasparente  
Transparent



Fumè  
Smoked

Vetro Marmo  
Marble glass  
**MARMOREFLEX®**



MATERIAL SHEET-D

Vetro Legno  
Wood glass  
**LEGNOREFLEX®**



MATERIAL SHEET-D



sp./thick 10+4 mm.

filo Wing/Wing edge

Vetro verniciato  
Lacquered glass

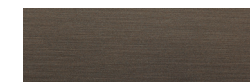

105M Ottone dark satinato  
105M Satin dark Brass

## BASE | 2

Legno  
Wood

finitura/finish

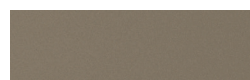

100M Bronze  
100M Bronze

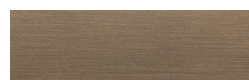

104M Ottone satinato  
104M Satin Brass



105M Ottone dark satinato  
105M Satin dark Brass

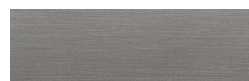

101M Titanium satinato  
101M Satin Titanium



Noce canaletto  
Canaletto walnut



Noce Canaletto Hennè  
Canaletto Hennè

VETRO, VETRO MARMO E VETRO LEGNO  
GLASS, MARBLE GLASS AND WOOD GLASS TOP

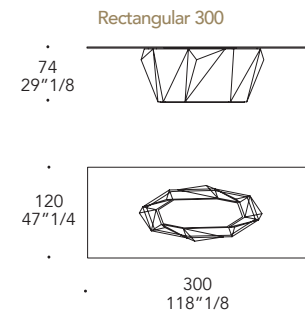
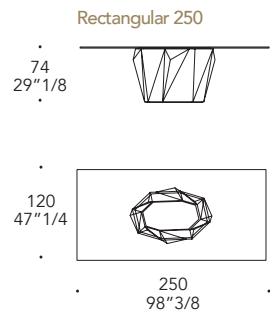
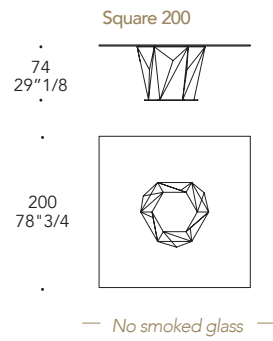
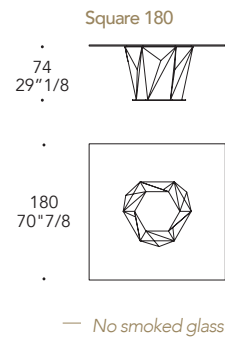

VETRO EXTRACHIARO O VERNICIATO OTTONE DARK 105M  
EXTRA CLEAR OR 105M DARK BRASS FINISH

